

aquatica®

Function, Form & Fashion



*True Ofuro Tranquility
Series Bathtubs*

Manual
(220V/50HZ)

 **WARNING**

1. READ AND FOLLOW ALL INSTRUCTIONS

2. WARNING: When using electrical products, basic precautions should always be followed, including the following:

3. DANGER: To reduce the risk of injury, do not permit children to use this unit unless they are closely supervised at all times.

4. Use this unit only for its intended use as described in this manual. Do not use attachments not recommended by the manufacturer.

5. Never drop or insert any object into any opening.

6. Do not operate this unit without the guard over the suction fitting.

7. DANGER: RISK OF ELECTRIC SHOCK. The unit must be connected only to a supply circuit that is protected by a ground-fault circuit-interrupter (GFCI) or Earth-Leakage Circuit-Breaker (ELCB). Such a GFCI should be provided by the installer and should be tested on a routine basis. To test the GFCI, push the test button. The GFCI should interrupt power. Push the reset button. Power should be restored. If the GFCI fails to operate in this manner, the GFCI is defective. If the GFCI interrupts power to the bathtub without the test button being pushed, a ground current is flowing, indicating the possibility of an electric shock. Do not use this hydromassage bathtub. Disconnect the hydromassage bathtub and have the problem corrected by a qualified service representative before using.

8. WARNING: RISK OF ELECTRIC SHOCK. A licensed electrician should make all electrical connections. Disconnect power before servicing.

9. WARNING: RISK OF INJURY OR PROPERTY DAMAGE. Please read all instructions thoroughly before beginning installation, including the following requirements.

10. Follow all local plumbing and electrical codes.

11. INSTALL TO PERMIT ACCESS FOR SERVICING.

12. (For permanently connected units) A green-colored terminal (or a wire connector marked G, GR, Ground, or Grounding) is provided within the terminal compartment. To reduce the risk of electric shock, connect this terminal or connector to the grounding terminal of your electric service or supply panel with a conductor equivalent in size to the circuit conductors supplying this equipment. A pressure wire connector is provided on the exterior of the pump or control within this unit to permit connection of a bonding conductor between this unit and all other exposed metal in the vicinity, as needed to comply with local requirements.

GROUNDING IS REQUIRED. The unit must be installed by a qualified service representative, and grounded. Building materials and wiring should be routed away from the pump body and other heat-producing components of the unit.

IMPORTANT PRODUCT INFORMATION

PRODUCT NOTICES

WARNING: Unauthorized modification may cause unsafe operation and poor performance of the bath. Do not relocate the pump, or make other modifications to the circulating system, as this could adversely affect the performance and safe operation of your bath. Aquatica Plumbing Group Inc. shall not be liable under its warranty or otherwise for personal injury or damage caused by any such unauthorized modification.

PRODUCT INSPECTION

Carefully unpack the product and inspect the unit for damage. Return the unit to the carton during construction to prevent damage.

FACTORY-ASSEMBLED FEATURES

Factory installed components include components like pump, blower, level sensors, in-line heater, submerged chromotherapy lights, keypad and diverter. The pump and piping are factory-assembled.

CONNECTIONS AND SERVICE ACCESS

NOTICE: For built-in and corner bathtubs provide unrestricted service access to the pump, heater and control box. Provide unrestricted service access to the pump, blower, in-line heater, and for built-in bathtubs you must construct an access panel to provide sufficient clearance for servicing the pump, inline heater, and control box. The access panel must be located immediately next to the pump and in line heater. Study the roughing-in information.



ELECTRICAL REQUIREMENTS

1. **DANGER: RISK OF ELECTRIC SHOCK.** The installation must have one (1) Class A GroundInterrupters (GFCI's) or Earth-Leakage Circuit Breakers (ELCB's). The GFCI/ELCB protects against line shock hazard. **Use a 208V-240V, 20A, 50/60 Hz dedicated service to wire the control system.**
2. **GROUNDING IS REQUIRED.** The unit should be installed by a qualified service representative and grounded.
3. Installation instructions shall identify fittings, such as brackets or hangers, that are necessary to the intended mounting of the unit.
4. The minimum structural strength required for the supporting surface for the unit. Need to provide rough in instructions to review for compliance.
5. Instructions shall indicate that building materials and wiring should be routed away from the pump body and other heat producing components.
6. **INSTALL TO PERMIT ACCESS FOR SERVICING**
7. An equipment bonding terminal is provided in the field wiring compartment. To reduce the risk of electric shock, this terminal must be connected to the bonding means provided in the electric supply panel with a conductor equivalent in size to the circuit conductors supplying this equipment.

True Ofuro Tranquility

Warning

8. INSTALL THIS UNIT IN ACCORDANCE WITH THE CANADIAN ELECTRICAL CODE, PART I. and INSTALLER CONFORMEMENT AU CODE CANADIEN DE L'ELECTRICITE, PREMIERE PARTIE (CSA C22.2 No. 218.2 compliance).

Your physiological response to hot water is subjective and depends on your age, health, and medical history. If you don't know your tolerance to hot water, or if you get a headache, or become dizzy or nauseous when using your hot tub, get out and cool off immediately.



WARNING

ELECTRICAL REQUIREMENTS

IMPORTANT! SAFETY INSTRUCTIONS / INSTRUCTIONS IMPORTANTES
RELATIVES A LA SECURITE

READ, FOLLOW ALL INSTRUCTIONS / LIRE ET SUIVRE TOUTES LES
INSTRUCTIONS

SAVE THESE INSTRUCTIONS / CONSERVER CES INSTRUCTIONS

1. WARNING: RISK OF ACCIDENTAL INJURY OR DROWNING. Children should not use hydromassage bathtub without adult supervision. / AVERTISSEMENT. RISQUE DE BLESSURE ET DE NOYADE. Ne pas laisser un enfant utiliser la cuve a remous en l'absence d'un adulte.
2. WARNING: RISK OF ACCIDENTAL INJURY OR DROWNING. Do not use hydromassage bathtub unless all suction guards are installed to prevent body and hair entrapment. / AVERTISSEMENT. RISQUE DE BLESSURE ET DE NOYADE. Pour éviter le happement de membres ou de cheveux, ne pas utiliser la.
3. WARNING: To avoid injury, exercise care when entering or exiting the hydromassage bathtub. /AVERTISSEMENT. Pour éviter les blessures, user de prudence en entrant dans la cuve a remous et en la quittant.
4. WARNING: RISK OF ACCIDENTAL INJURY OR DROWNING. Do not use drugs or alcohol before or during the use of a hydromassage bathtub equipped with heater to avoid unconsciousness and possible drowning. / AVERTISSEMENT. RISQUE DE BLESSURE ET DE NOYADE. Ne pas prendre de médicament ni consommer d'alcool lorsqu'on utilise une cuve à remous chauffée ou avant d'y entrer afin d'éviter l'évanouissement et le risque de noyade.
5. WARNING: RISK OF FETAL INJURY. Pregnant or possibly pregnant women should consult a physician before using a hydromassage bathtub equipped with heater. / AVERTISSEMENT. DANGER POUR LE FOETUS. Les femmes enceintes, que leur grossesse soit confirmée ou non, devraient consulter un médecin avant d'utiliser une cuve à remous chauffée.
6. WARNING: RISK OF HYPERTHERMIA AND POSSIBLE DROWNING. Do not use a hydromassage bathtub equipped with heater immediately following strenuous exercise. / AVERTISSEMENT. RISQUE D'HYPERTHERMIE ET DE NOYADE. Ne pas utiliser une cuve à remous chauffée après un exercice intense.

Warning

7. WARNING: RISK OF ELECTRIC SHOCK. Do not permit electric appliances (such as a hair dryer, lamp, telephone, radio, or television) within 1.5 m of this hydromassage bathtub. / AVERTISSEMENT. RISQUE DE CHOC ELECTRIQUE. Ne pas placer d'appareils electriques (luminaire, téléphone, radio, televeiseur, etc.) a moins de 1.5 m de cette cuve a remous.

8. CAUTION: Test the ground fault circuit interrupter protecting this appliance periodically in accordance with the manufacturer's instructions. / ATTENTION. Verifier regulierement le fonctionnement du disjoncteur de fuite a la terre conformement aux instructions du fabricant.

9. WARNING: RISK OF HYPERTHERMIA AND POSSIBLE DROWNING. Water temperature in excess of 38 °c can be injurious to your health. check and adjust water temperature before use. / AVERTISSEMENT. RISQUE D'HYPERTHERMIE ET DE NOYADE. Une température d'eau supérieure à 38 °c peut présenter un risque pour la santé. vérifier et régler la température de l'eau avant d'utiliser la cuve .

10. WARNING: RISK OF HYPERTHERMIA. People using medications and/or having an adverse medical history should consult a physician before using a hydromassage bathtub equipped with heater. / AVERTISSEMENT. RISQUE D'HYPERTHERMIE. Les personnes qui prennent des médicaments ou qui ont des problèmes de santé devraient consulter un médecin avant d'utiliser une cuve à remous chauffée.



CAUTION



DANGER

Since your hot tub can be set to reach temperatures of 40°C (104° F), users should be aware that extended submersion in water that exceeds normal body temperature can lead to hyperthermia.

The causes, symptoms and effects of hyperthermia may be described as follows:

Hyperthermia occurs when the internal temperature of the body reaches several degrees above the normal body temperature of 37°C (98.6°F). The symptoms of hyperthermia include drowsiness, lethargy, and an increase in the internal temperature of the body.

The effects of hyperthermia include:

- Unawareness of impending hazard
- Failure to perceive heat
- Failure to recognize the need to exit the hot tub
- Physical inability to exit the hot tub
- Fetal damage in pregnant woman
- Unconsciousness resulting in the danger of drowning

If you sense any of the symptoms of hyperthermia, safely exit the hot tub immediately.

The use of alcohol, drugs or medication can significantly increase the risk of fatal hyperthermia.

True Ofuro Tranquility

Electrical Manual

AC JUNCTION BOX

Connect to your home electrical system via our AC junction box solely! Use #12 AWG size wire and 20A breaker to connect to your home's electrical system.

JUNCTION BOX WIRE COLOR MARKINGS:

- Black - L1
- White - N
- Green - Ground

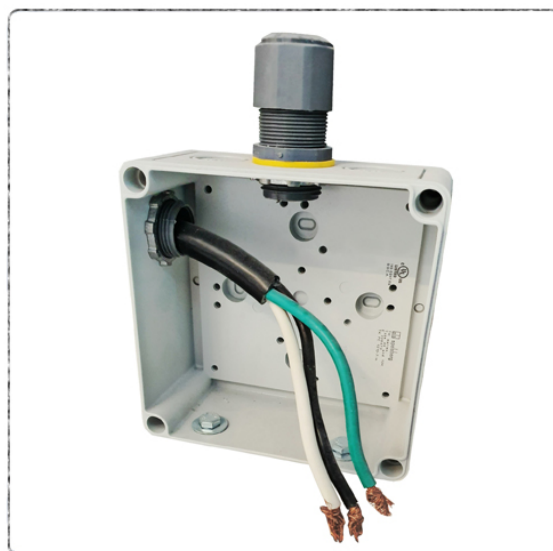

BATH CONTROLLER ENCLOSURE

Do not tamper with our bath controller enclosure. It is pre-configured and pre-wired. Opening and tempering might void our warranty.

! DANGER

CONNECT ONLY TO A CIRCUIT THAT IS PROTECTED BY A GROUND-FAULT CIRCUIT-INTERRUPTER (GFCI).
FOR INDOOR USE ONLY.
UTILISER A L'INTERIEUR SEULEMENT



RISK OF ELECTRICAL SHOCK

! WARNING

ELECTRIC SHOCK HAZARD.
This equipment is to be serviced by trained personnel only.

! WARNING

220 VOLTS
CONTACT MAY CAUSE ELECTRICAL SHOCK AND INJURY. DISCONNECT ALL POWER BEFORE SERVICING

! WARNING

220 VOLTS

IMPORTANT

THIS PRODUCT REQUIRES THE FOLLOWING SPECIFICATIONS. BEFORE INSTALLATION, PLEASE ENSURE YOUR BREAKER PANEL CAN ACCOMMODATE THE SPECIFICATIONS OF THIS UNIT.

INSTALLATION MUST BE DONE BY A LICENSED PROFESSIONAL.

VOLTAGE	220V
AMPS	20A
FREQUENCY	60HZ
CABLE REQUIRED	12 AWG WITH GROUND

MODEL NUMBER	SERIAL NUMBER	MFG DATE

CONNECT ONLY TO A BRANCH CIRCUIT PROTECTED BY AN OVERCURRENT PROTECTION DEVICE RATED NOT MORE THAN 20A.
BRANCHER À UNE DÉRIVATION PROTÉGÉE PAR UN DISPOSITIF DE PROTECTION CONTRE LES SURINTENSITÉS D'AU PLUS 20A.

CAUTION: TO REDUCE THE RISK OF SHOCK AND FIRE HAZARD, REPLACE ONLY WITH THE SAME TYPE 20A, 220V FUSE.

ATTENTION: POUR NE PAS COMPROMETTRE LA PROTECTION CONTRE LE RISQUE DE CHOC ÉLECTRIQUE ET D'INCENDIE, REMPLACER SEULEMENT PAR UN FUSIBLE DE MÊME TYPE, DE 20A ET DE 220V.

International Series

Fully Pre-Installed System

No user configuration required

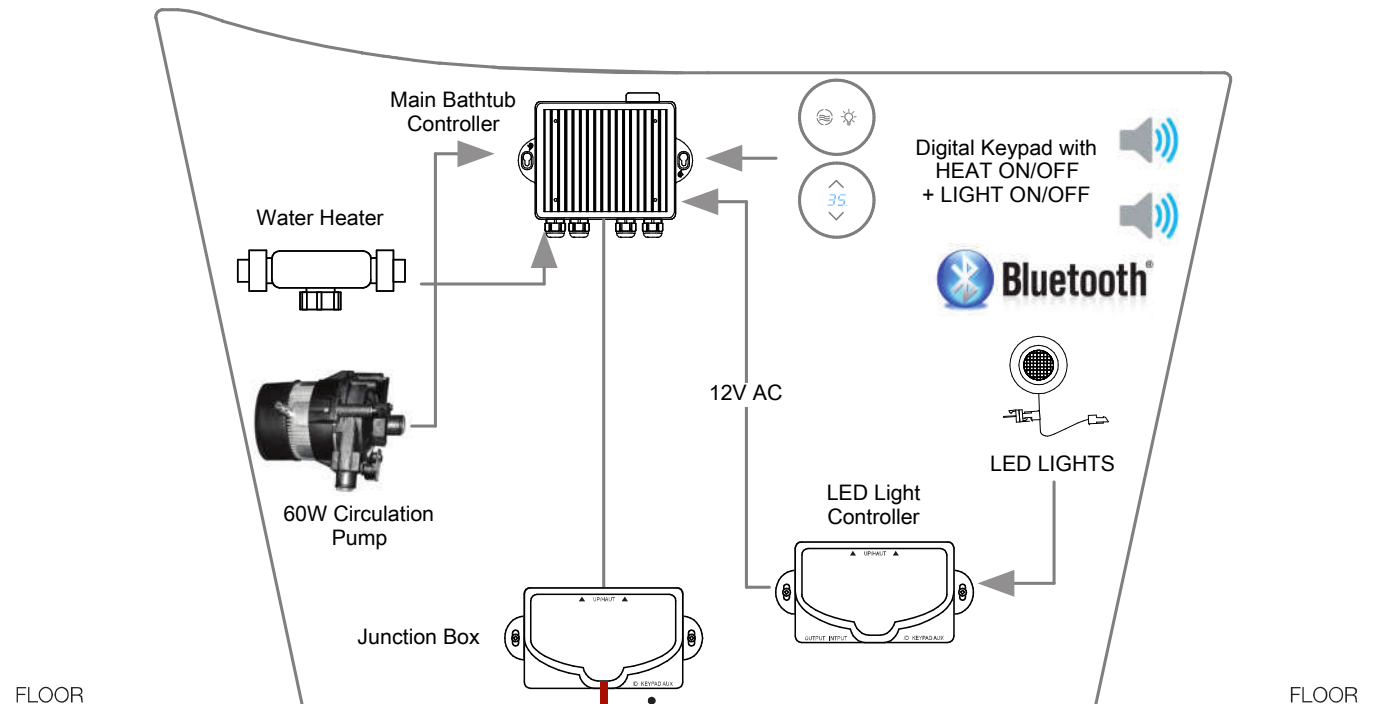

ENSURING THAT THERE IS SUFFICIENT AIR CAVITY BETWEEN THE BATHTUB AND THE FLOOR

Upon installing the bathtub ensure that a sufficient cavity is left between the bath and the floor. Do NOT silicone the entire perimeter. The exterior bath walls should NOT touch the floor. Silicon some sections of the skirt allowing for sufficient air intake and ventilation. Insufficient air cavity volume beneath the bath can lead to low performance. Confirm with your installer that proper sizing and/or venting recommendations have been followed.

SIMPLICITY:

- 1 Wire the bath to the main breaker panel (16A RCBO). 240 volts electrical current will need to be supplied to the junction box installed underneath the Tranquility bathtub. The electrical cord with Live, Neutral and Ground wires can be fed through the 1/2" strain relief cord connector installed on the junction box.
- 2 Enjoy your Aquatica® Tranquility bathtub.

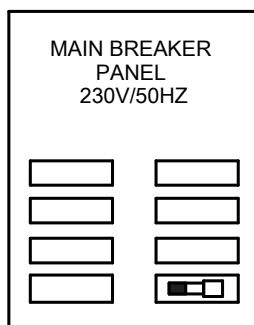

IMPORTANT:

16A/230V BREAKER WITH RCD SAFETY SWITCH
(aka RCBO (residual-current circuit breaker with overcurrent protection)
(ONE 16A/230 VOLT CIRCUIT.)

True Ofuro Tranquility

Installation

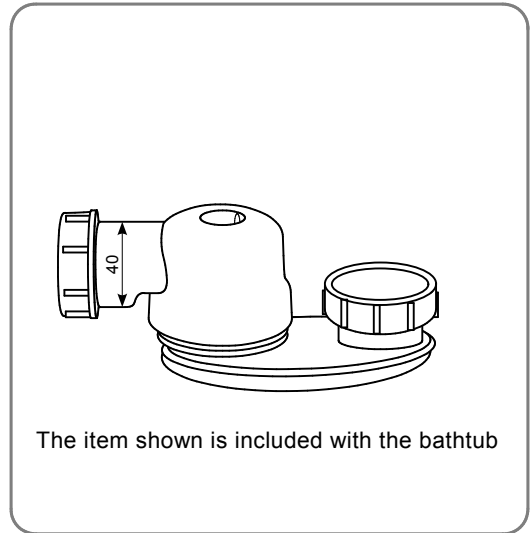
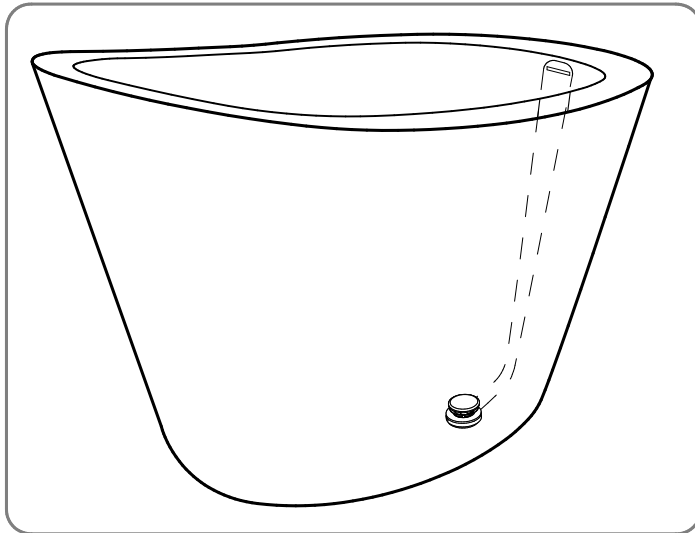

The item shown is included with the bathtub

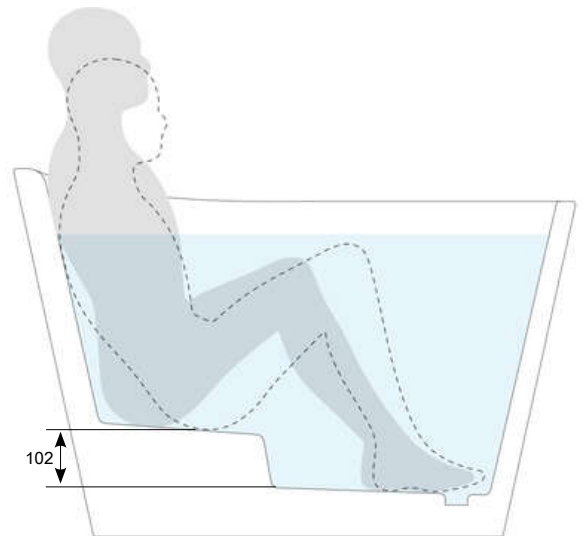
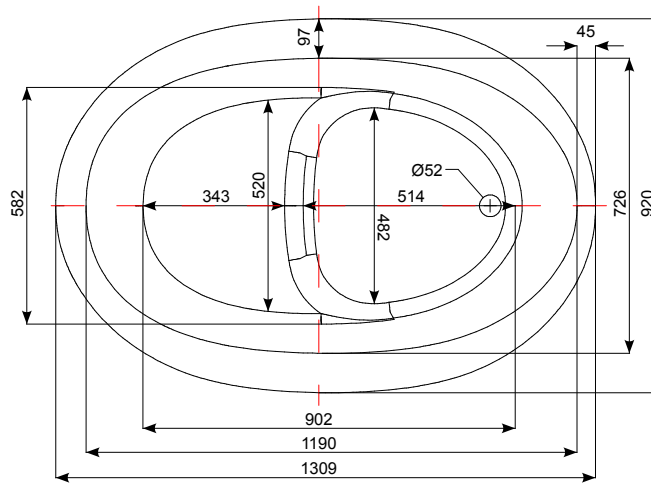
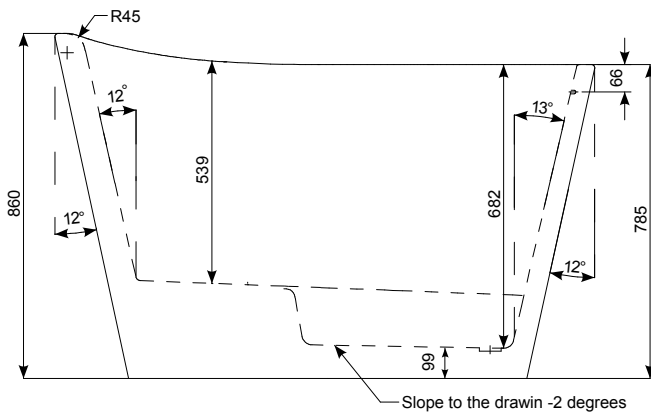
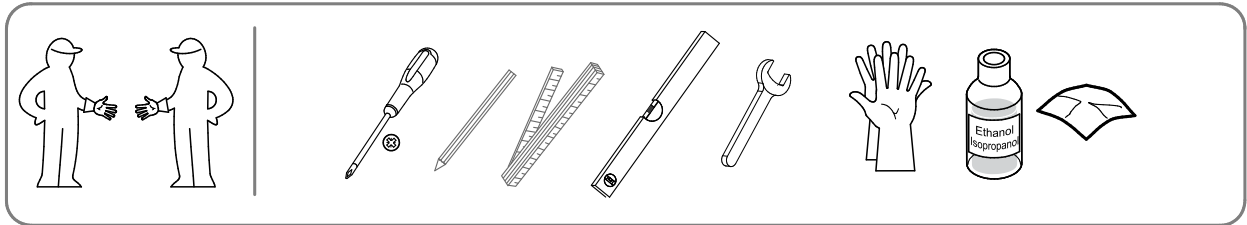

EUROPE - MANDATORY INSTALL PROCEDURE

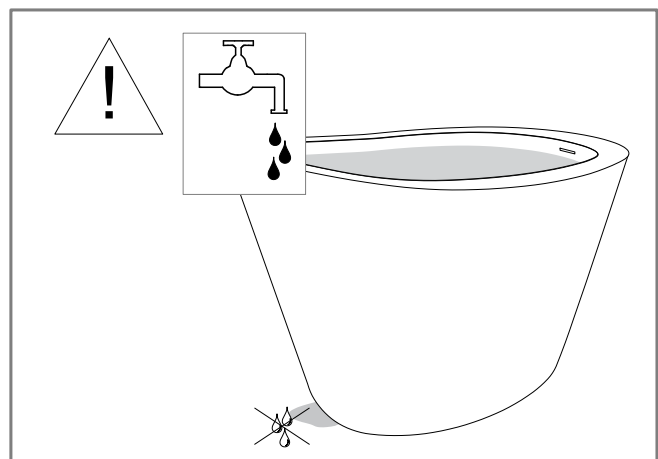
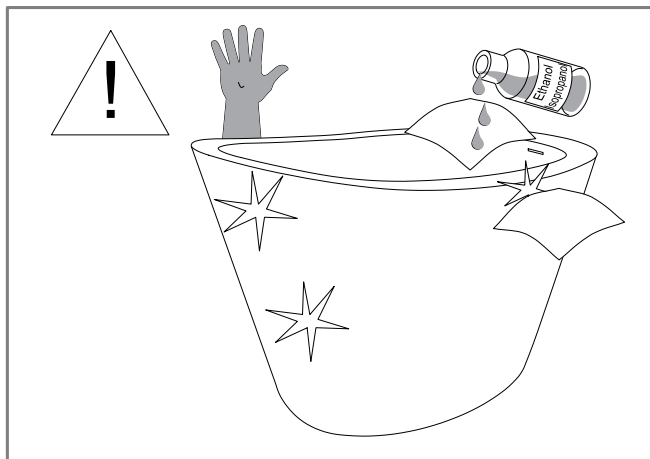
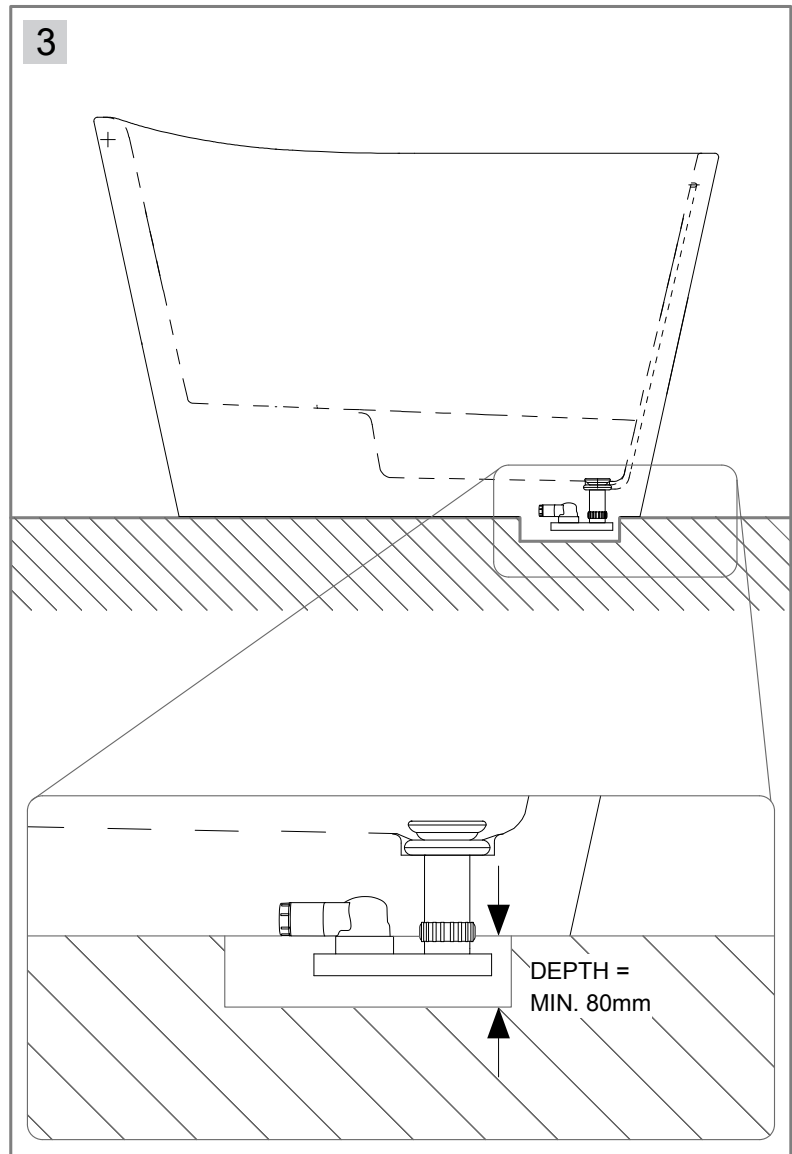
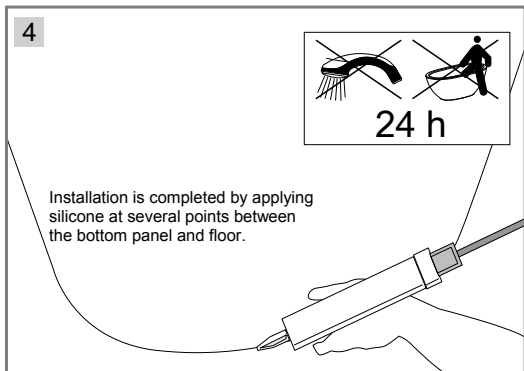
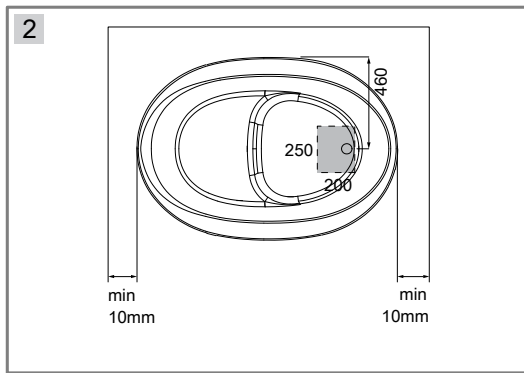
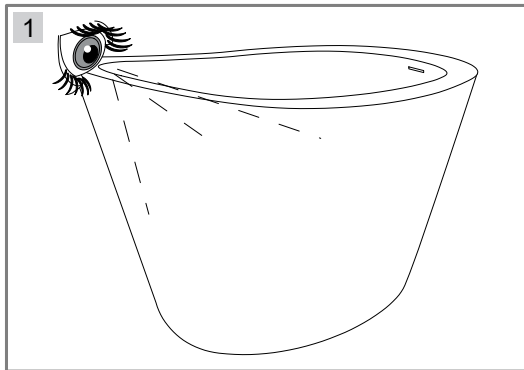

True Ofuro Tranquility

Maintenance

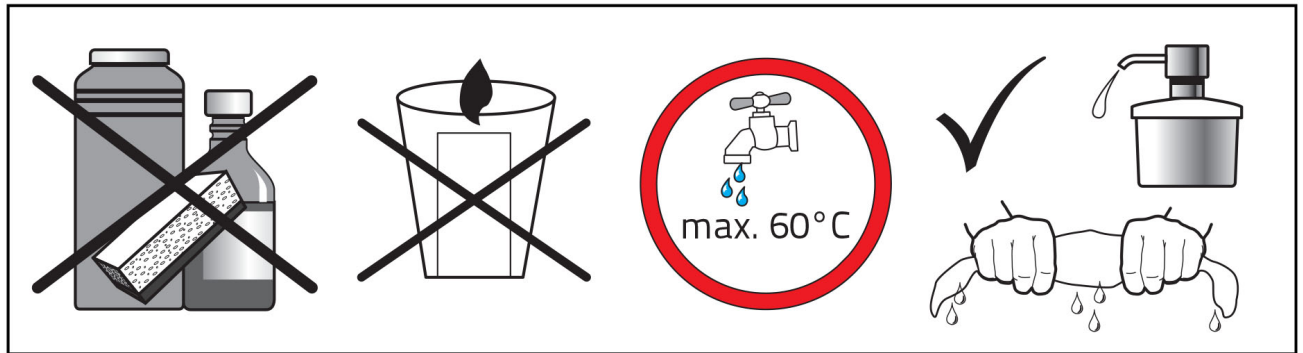

Maintenance Instructions

The smooth surface of your Aquatic® AquateX™ Bathtub accumulates hardly any dirt, and can be maintained by simply cleaning with a soft cloth, using a mild detergent in water, then wiping over with a dry cloth.

Avoid using abrasive cleansers or solvents, which will cause damage to the surface. Damage caused by use of these products, or any other inappropriate treatment, is not covered by our guarantee.



Инструкция по уходу

Поверхность легко чистится. За счет гладкости грязь к ней не прилипает. Для регулярного ухода используйте мягкую ткань, мыльный раствор и воду. После чистки вытирайте поверхность сухой тканью, которая хорошо впитывает влагу.

Не используйте губки с абразивной поверхностью и агрессивные растворители, которые могут повредить ванну. Повреждения, возникшие вследствие неправильного ухода, не покрываются гарантией.



Installation & Entretien

Cette surface est facile à entretenir et à nettoyer. Sa surface particulièrement lisse, ne retiens que très peu la saleté. Un entretien quotidien nécessite simplement l'utilisation d'un chiffon doux, de l'eau et un peu de savon. Essuyer avec un chiffon sec. L'utilisation de détergents ou de solvants endommageraient cette surface. Les dommages resultants d'un traitement non conforme effectué par l'utilisateur sont exclus de la garantie que nous offrons.



Manuale per il corretto mantenimento

La superficie necessita di pulizia ed accorgimenti per il corretto mantenimento. Una superficie liscia non accumula lo sporco. Usare una spugnetta con del detergente non aggressivo per una pulizia regolare. Asciugare con un panno. Evitare l'uso di solventi o materiali abrasivi: potrebbero rovinare la superficie.

Un danno causato da trattamento inappropriato non verrà coperto dalla garanzia.



Instrucciones para la correcta manutención

La superficie debe de ser limpiada y adecuadamente mantenida. Una superficie lisa no acumula suciedad.

Utilice una esponja con un detergente suave para la limpieza diaria. Seque con un paño.

No utilice disolventes o materiales abrasivos ya que podrían dañar la superficie.



Los daños causados por el tratamiento inadecuado no serán cubiertos por la garantía.

The True Ofuro Tranquility series bathtubs are easy to operate and fun to use.

The control system consists of
2 keypads as follows:

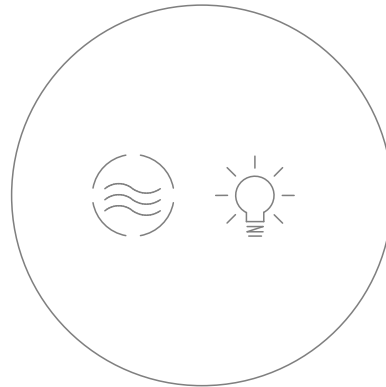
On/Off and Lights On/Off



Activate the heating and circulation feature by touching the  icon, the icon will light up when activated. This feature will only activate once sufficient water level has been reached. As per safety regulation, the heating feature is programmed to automatically shut down after 20 minutes from time of activation, simply touch the  icon again to reactivate.

Activate the lighting feature by touching the  icon, the icon will light up when activated. Tap to cycle through the various modes/effects, similar to what is depicted on the image below. Touch and hold for a few seconds to turn off.

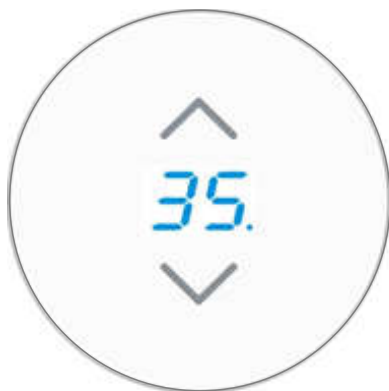

Temperature Adjustment Function

The round 2-digit display is the temperature controller. When the Tranquility is powered it will reflect the current water temperature. By tapping the up or down icon, it will increase or decrease set temperature. When increasing or decreasing set temps, the display will change from current water temperature to reflect settings temperature. The setting temperature will show for a few seconds when adjusting before changing back to current water temperature. The maximum allowed temperature is +40C (104F).

True Ofuro Tranquility

Operating Manual

CURRENT SYSTEM LIMITATIONS

Temperature Adjustment Function in 220V Systems

The Tranquility heating system in the 220V/240V systems is intended to maintain the temperature.

Temperature Display in Degrees (220V) / Fahrenheits (240V)

Please note that since the display is a 2-digit display after exceeding 99F the temperature will be displayed according to the following format:

100F	A0
101F	A1
102F	A2
103F	A3
104F	A4

